



# TINO

## FREEDOM TO WORK UNINHIBITED

Tino redefines the way light brightens your workspace. Designed to mount directly to a monitor, it frees up your desktop area. Although small, Tino is powerful—projecting up to 98 footcandles-worth of illumination, a full foot forward from its base—or lack thereof.

### FEATURES AVAILABLE

- Asymmetrical illumination
- Single arm
- Dimming
- Occupancy sensor
- Multiple mounting options
- Premium color options:



# TINO

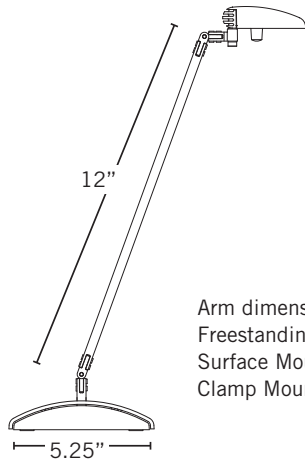

Arm dimensions for:  
Freestanding  
Surface Mount  
Clamp Mount

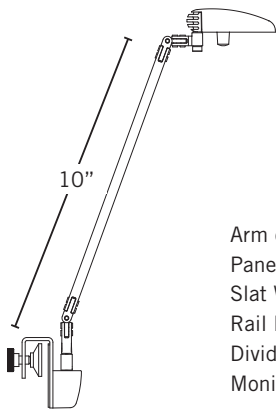

Arm dimensions for:  
Panel Mount  
Slat Wall Mount  
Rail Mount  
Divider Mounts  
Monitor Mount

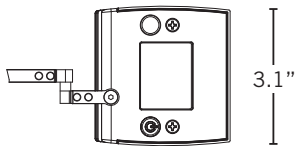
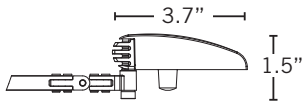

### Environmental considerations:

- Made with fully-recyclable aluminum
- Energy-efficient occupancy sensor
- Mercury-free LEDs
- LEED credit eligibility

\*A footcandle plot is available at [www.lightcorp.com/products/desk/tino](http://www.lightcorp.com/products/desk/tino).

## FEATURES

- Asymmetrical illumination projects 98 footcandles on the desktop approximately 1' in front of the head.
- Nine mounting options to suit a variety of workspace configurations. See page 40 for mounting option descriptions.
- The occupancy sensor will turn the fixture off after 30 minutes of inactivity and back on as the user re-enters the workspace. If occupant is present, the light will remain on.
- Single-touch on/off and touch-and-hold continuous dimming with last state memory.

## SPECIFICATIONS

Energy consumption:	4.2 system watts
Number of LEDs:	7 fractional LEDs
Light output:	200 lumens; 52 Lm/W
Peak footcandles:	98 @ 15" from work surface*
LED rated lifespan:	> 50,000 hours
Color temperature:	3500K
Color rendering index:	82
Brightness adjustability:	100%—15% continuous
Arm options:	single
Mounting options:	freestanding base, slat wall, surface, monitor, rail, panel, clamp and two divider mount options
Standard colors:	white, silver, black
Non-standard colors:	merlot, sky, ocean, kiwi, clementine, cranberry
Materials:	aluminum, zinc and plastic
Power supply:	18-watt wall transformer with 9' black cord
Cord:	4' silver cord with quick connector
Certifications:	ETL listed: compliant to UL 153/8750 & CSA C22.2 No. 250.4; FCC Part 15 Class B; TAA; BAA; CEC Title 20
Warranty:	10 years fixture; 5 years power supply

## SPECIFYING NOTES

- Tino can mount to dividers ranging in thickness of 1/4" to 1-1/2" and heights up to 30" above the work surface.
- The freestanding base weighs 4.4 lbs.
- Cord managers available.

## MOUNTING OPTIONS



**Freestanding Base**

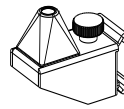

**Slat Wall Mount**



**Surface Mount**

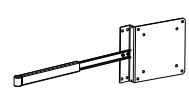

**Monitor Mount**  
fits most 15"-17" monitors with standard VESA mounting patterns (100mm x 100mm and 75mm x 75mm)

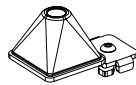

**Rail Mount**

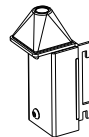

**Panel Mount**



**Clamp Mount**  
0.9" to 1.875" thickness

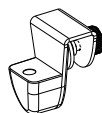

**Divider Mount 1**  
1/4" to 3/8" thickness

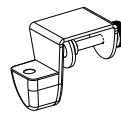

**Divider Mount 2**  
1/2" to 1-1/2" thickness

	DESCRIPTION	CODE
<b>Step 1: Select color</b>	Black finish	TINO.BLACK
	Silver finish	TINO.SILVER
	White finish	TINO.WHITE
<b>Step 2: Select mounting</b>	Freestanding base	+.FS
	Monitor mount	+.MM
	Panel mount*	+.PM
	Surface mount	+.SM
	Slat Wall mount**	+.SW
	Clamp mount	+.CM
	Rail mount	+.RM
	Divider mount 1	+.DM1
Divider mount 2	+.DM2	
<b>Step 3: Add options</b>	Non-standard color:	
	Kiwi	+.305
	Clementine	+.306
	Cranberry	+.307
	Merlot	+.308
	Sky	+.309
	Ocean	+.310

**NOTE:**

\*A system mounting code must be specified for panel mount. Please call customer service at 800.544.4899 for details.

\*\*For slat wall mounting, please call customer service for system mounting availability.



**WARNING:** This product may expose you to chemicals including di(2-ethylhexyl) phthalate (DEHP), lead and/or titanium dioxide which are known to the State of California to cause cancer and birth defects or other reproductive harm. For more information, go to [www.P65Warnings.ca.gov](http://www.P65Warnings.ca.gov).