

NIK

*Nik can integrate within, below or clamp on to your worksurface to provide convenient power at the ready. Choose from three configurations of outlets featuring up to two AC receptacles or four USB charging ports to support your unique power needs. And with 30 finish color options available, Nik blends tastefully with your furniture, or can serve as a standout pop of color on your desktop landscape. **Proudly designed and manufactured in Grand Haven, Michigan.***



NIK

Features

- Choose from three standard receptacle configurations
- Three mounting options available
- Aluminum housing can be powder coated in 30 finishes
- Includes both standard (1.5A) and fast-charging (2.4A) USB ports for rapid re-charging
- Choose from PVC cord in black or white, or woven fabric cord available in 4 colors
- Gradually powers down as charging cycles end to prevent over-heating and/or over-charging
- Tool-free installation for clamp-mounted units

Specifications

AC receptacles:	120V, 15A
USB Charge Ports:	2.4A and 1.5A, Type A
Plastic Cord:	6' or 10' 14/3 AWG PVC cord available in black or white, straight plug standard
Woven cord:	10' cord available in 4 colors, low-profile, 45-degree plug straight or 90-degree angle (available as a special order)
Strain relief:	
Max. surface thickness:	clamps on or insets into surfaces of 3/4" – 1-1/4" thickness

Configurations



1x AC receptacle & 2x USB



1x AC receptacle & 4x USB



2x AC receptacles & 2x USB

Mountings



In-surface
(Available Q4 2020)



Under-surface



Clamp-on

Finishes



AC Receptacle Colors

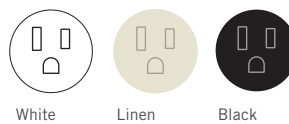

Woven Cord Colors

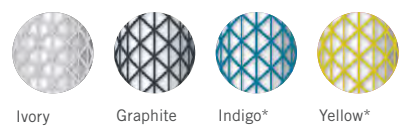

*Special Order

NIK

Dimensions

Face Plates/In-surface mount

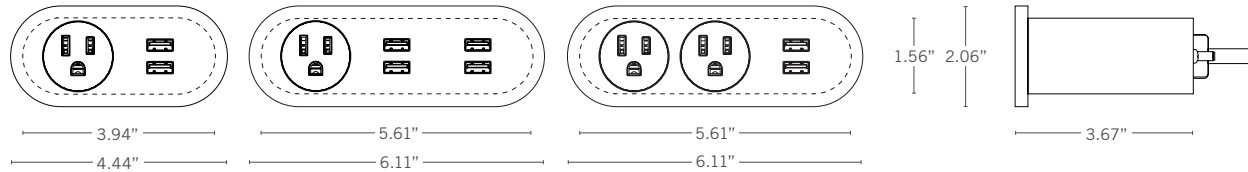

Clamp-on mount

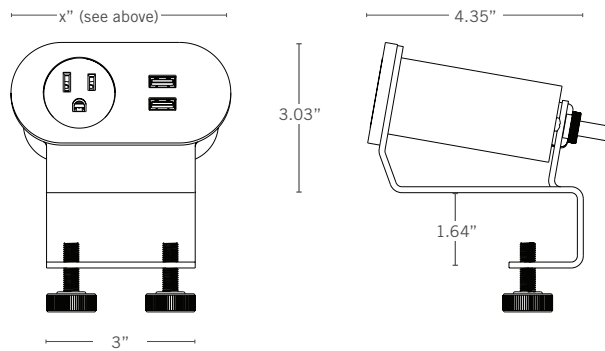

Under-surface mount

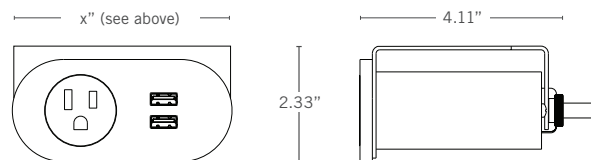

Specifying Notes

- AC receptacles can be custom-built at the factory with standard (south) orientation (ground pin down), or rotated to north (ground pin up), east (ground pin right), or west-facing (ground pin left) orientations
- Customizable cord exit angle

Certifications

- UL962A listed
- UL 1310 listed power supply
- FCC CFR-47 Part 15 Class B
- Canada C22.2 308-18
- TAA
- USB ports compliant to USB-IF BC 1.2

Warranty

Nik is warranted for two years from the date of manufacture.

Lead Time

3-day lead time available for the following configuration:

- Clamp mount 2x AC receptacles/2x USB with white housing/white receptacles, standard (south) outlet orientation and 6' white plastic cord. Limit 10 units. (Part number: NIK.AC.AC.USB.WT.OUTLET.WHITE.BODY.6W.S.CM)

All other configurations ship within our standard 10-day lead time (excluding special orders).